

# Ecoboiler 12 HE Inset



Code	EB12HE-INSET-G4
Output to water	11.6kW
Log length	305mm
Nett efficiency	72.7%
Width	548mm
Height	590mm
Depth	578mm

The inset version of the Ecoboiler HE range provides high efficiency whilst fitting perfectly into a standard British fireplace opening. Featuring a large curved viewing glass, simple controls and the ultimate in state-of-the-art boiler stove technology, our inset Ecoboiler will transform any fireplace with its sophisticated style.

## Features

- 5 year guarantee
- Easily accessible water sensor for trouble-free maintenance
- Pre-heated airwash system for sparkling clean glass
- Burns wood or solid fuel
- Stainless steel ash pan
- Compact space-saving design
- Discreetly positioned thermostatic control fitted as standard 'Easy Boost' system
- Large, externally controlled riddling grate
- Fits into standard British fireplace opening
- Flue Exhaust Diversion system to improve performance
- Primary and secondary burn to improve efficiency
- Suitable for installation in an indirect/open-vented central heating system
- Up to 3 Bar operating pressure

## Optional Extras

- Arada Ash Carrier - Small - [ARA016]



## Ecoboiler 12 HE Inset - Technical Information

Code	EB12HE-INSET-G4
Output range to room	2-5kW
Output range to water	4-14kW
Nett efficiency	72.7%
Width	548mm
Height	590mm
Depth	578mm
Depth of front fascia	179mm
Width in fireplace	412mm
Height in fireplace	532mm
Depth into fireplace	353mm
Depth of back to centre of top flue	110mm
Flue diameter	127mm
Suitable for 12mm hearth	No
Under hearth temperature	189.0°C
Suitable for direct air supply kit	No
Packed weight	114kg
Maximum log length	305mm

## Minimum Distance To Combustibles

To sides of stove	175 mm
Above stove	75 mm

## Boiler Tapping Measurements

Distance A	139 mm
Distance B	165 mm
Distance C	49 mm
Distance D	345 mm
Distance E	172 mm

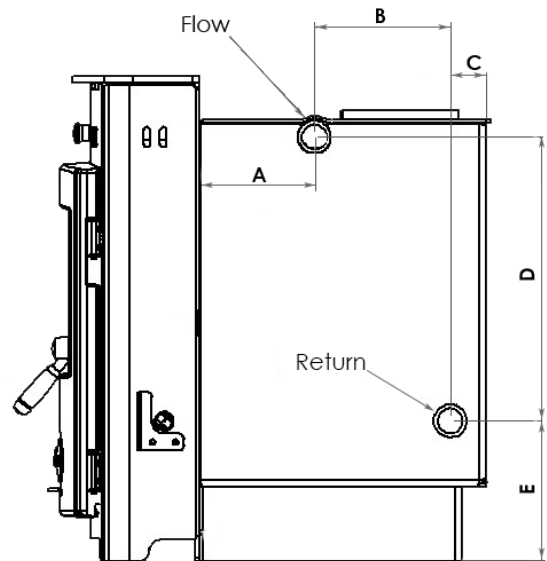

Inset Boiler Tapping Measurements.  
Side view example shown. Not to scale.